



Radio / CD / MP3

Acapulco MP54

7 644 252 310

Casablanca MP54

7 644 250 310



Operating instructions

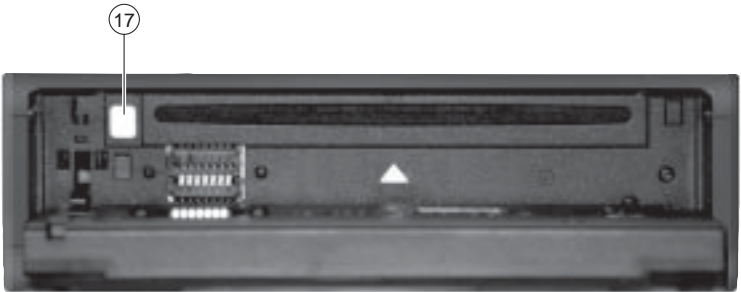
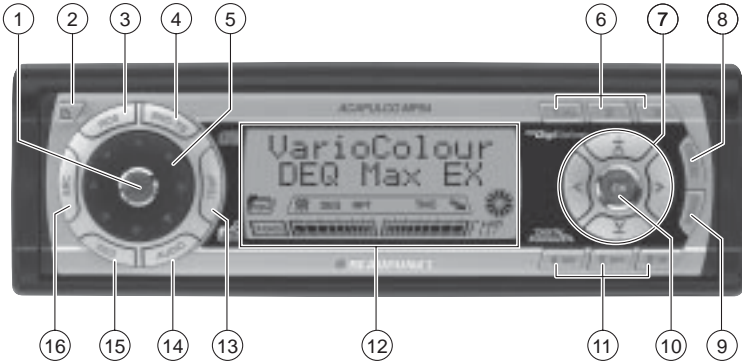

 **BLAUPUNKT**

Open here



- ① Button to switch the device on/off and operate the volume mute feature
- ②  button to open the flip-release control panel
- ③ **RDS** button to switch the RDS function on/off (Radio Data System).
- ④ **BND** button (band) to select radio mode as the source, to select the FM memory banks and the MW and LW wavebands
TS to start the Travelstore function
- ⑤ Volume control
- ⑥ Keys **1 - 3**
- ⑦ Arrow buttons
- ⑧ **DIS•ESC** button to change the display content and close menus.
- ⑨ **MENU** button to open the basic settings menu.
Long press: Deactivate / activate demo mode.
- ⑩ **OK** button to confirm menu entries and activate the scan function.
- ⑪ Keys **4 - 6**
- ⑫ Display
- ⑬ **TRAF** button to switch traffic information standby on/off.
- ⑭ **AUDIO** button to adjust the bass, treble, balance and fader.
- ⑮ **DEQ** button to activate/deactivate and set up the equalizer.
- ⑯ **SRC** button to switch between the CD/MP3, CD changer (if connected) and AUX sources.
- ⑰  button to eject the CD from the device

CONTENTS

Notes and accessories	50	Switching bandwidth during interference (SHARX)	60
Road safety	50	Configuring the display	60
Installation	50	Naming radio stations (only FM)	60
Accessories	50	Activating/deactivating the radio text display	61
Activating / deactivating demo mode	51	Traffic information	61
Detachable control panel	51	Switching traffic information priority on/off	61
Theft protection	51	Setting the volume for traffic announcements	62
Detaching the control panel	51	CD mode	62
Attaching the control panel	52	Switching to CD mode	62
Switching on/off	52	Selecting tracks	63
Adjusting the volume	53	Fast track selection	63
Setting the power-on volume	53	Fast searching (audible)	63
Instantaneously decreasing the volume (mute)	53	Random track play (MIX)	63
Telephone audio / navigation audio	53	Scanning tracks (SCAN)	63
Setting the volume of the confirmation beep	54	Repeating tracks (REPEAT)	64
Automatic sound	55	Pausing playback (PAUSE)	64
Radio mode	55	Changing the display	64
Switching to radio mode	55	Displaying CD text/CD name	64
Convenient RDS functions (AF, REG)	55	Naming CDs	65
Selecting the waveband / memory bank	56	Traffic announcements in CD mode ..	66
Tuning into a station	56	Ejecting a CD	66
Setting the sensitivity of station seek tuning	57	MP3 mode	67
Storing stations	57	Preparing an MP3-CD	67
Storing stations automatically (Travelstore)	57	Switching to MP3 mode	68
Listening to stored stations	57	Configuring the display	68
Scanning receivable stations (SCAN)	58	Selecting a directory	69
Setting the scanning time	58	Selecting tracks	70
Programme type (PTY)	58	Fast searching (not in MP3 browse mode)	70
Optimising radio reception	59	Random track play – MIX (not in MP3 browse mode)	70
		Scanning tracks – SCAN (not in MP3 browse mode)	70

Repeating individual tracks or whole directories – REPEAT (not in MP3 browse mode)	71
Pausing playback (PAUSE)	71
CD-changer mode	72
Switching to CD-changer mode	72
Selecting CDs	72
Selecting tracks	72
Fast searching (audible)	72
Changing the display	72
Repeating individual tracks or whole CDs (REPEAT)	73
Random track play (MIX)	73
Scanning all tracks on all CDs (SCAN)	73
Pausing playback (PAUSE)	73
Naming CDs	74
CLOCK time	75
Displaying the time	75
Setting the clock automatically	75
Setting the clock manually	75
Selecting 12/24-hour clock mode ..	76
Displaying the time continuously when the device is off and the ignition is on	76
Sound	77
Adjusting the bass	77
Adjusting the treble	77
Setting the left/right volume distribution (balance)	77
Adjusting the front/rear volume distribution (fader)	77
X-BASS	78
Equalizer	78
Switching the equalizer on/off	78
Selecting sound presets	79
Selecting vehicle presets	79
Automatic equalizer calibration (only Acapulco MP54)	79
Manually adjusting the equalizer	80
Help adjusting the equalizer	82
Adjusting the display settings	83
Switching the bar graph on/off	83
Switching the power meter on/off ..	83
Adjusting the display brightness	83
Adjusting the viewing angle	84
Setting the display illumination colour (only Acapulco MP54)	84
External audio sources	86
Switching the AUX input on/off	86
TMC for dynamic navigation systems	87
Specifications	87
Amplifier	87
Tuner	87
CD	87
Pre-amp out	87
Input sensitivity	87

Notes and accessories

Thank you for choosing a Blaupunkt product. We hope you enjoy using this new piece of equipment.

Please read these operating instructions before using the equipment for the first time.

The Blaupunkt editors are constantly working on making the operating instructions clearer and easier to understand. However, if you still have any questions on how to operate the device, please contact your dealer or the telephone hotline for your country. You will find the telephone number printed at the back of this booklet.

We provide a manufacturer guarantee for our products bought within the European Union. You can view the guarantee conditions at www.blaupunkt.de or ask for them directly at:

Blaupunkt GmbH
Hotline
Robert Bosch Str. 200
31139 Hildesheim
Germany

Road safety

 Road safety has absolute priority. Only operate your car sound system if the road and traffic conditions allow you to do so. Familiarise yourself with the device before setting off on your journey.

You should always be able to hear police, fire and ambulance sirens in good time from inside your vehicle. For this reason, listen to your car sound system at a suitable volume level during your journey.

Installation

If you want to install your car sound system yourself, please read the installation and connection instructions that follow these operating instructions.

Accessories

Only use accessories approved by Blaupunkt.

Remote control

The optional RC08 or RC10 remote control allows you to access the most important functions of your car sound system safely and conveniently from your steering wheel.

You cannot switch the device on/off using the remote control.

Amplifiers

You can use all Blaupunkt and Velocity amplifiers.

CD changers

You can connect the following Blaupunkt CD changers:
CDC A 08, IDC A 09 and CDC A 03.

Compact Drive MP3

You can connect the Compact Drive MP3 instead of a CD-changer in order to play MP3 music tracks. If you decide to connect a Compact Drive MP3, you will first need to use a computer to store the MP3 music tracks on the Microdrive™ hard disk that is inside the Compact Drive MP3. Then, when the Compact Drive MP3 is connected to the car sound system, you can play the tracks like normal CD music tracks.

The Compact Drive MP3 is operated in a similar way to a CD-changer. Most of the CD-changer functions can also be used with the Compact Drive MP3.

Activating / deactivating demo mode

The device is supplied from the factory with demo mode activated. The various functions of the device are displayed graphically as animations in the display during demo mode. You can also deactivate demo mode.

- ⇨ Press and hold down the **MENU** button (9) for longer than four seconds to activate/deactivate demo mode.

Detachable control panel

Theft protection

The device is equipped with a detachable control panel (flip-release panel) as a way of protecting your equipment against theft. The device is worthless to a thief without this control panel.

Protect your device against theft by taking the control panel with you whenever you leave your vehicle. Do not leave the control panel inside your vehicle - not even in a hiding place.

The control panel has been designed to be easy to use.

Note:

- Never drop the control panel.
- Never expose the control panel to direct sunlight or other heat sources.
- Avoid direct skin contact with the control panel's electrical contacts. If necessary, clean the contacts with a lint-free cloth and some alcohol.

Detaching the control panel

- ⇨ Press button (2).

The control panel opens out towards you.

- ⇨ Hold the control panel by its right side and then pull the control panel straight out of the bracket.

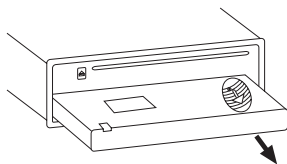

Note:

- All the current settings are saved.
- Any CD already inserted in the device remains there.
- The device switches off automatically after approx. one minute.

Attaching the control panel

- ⇒ Hold the control panel at approximately right angles to the device.
- ⇒ Slide the control panel into the device's guides that are positioned on the left and right at the lower edge of the housing. Push the control panel carefully into the bracket until it clicks into place.
- ⇒ Flip up the control panel and carefully press it into the device until it clicks into place.

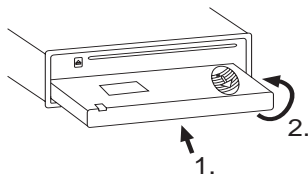

Note:

- When attaching the control panel, make sure you do not press the display.

If the device was still switched on when you removed the control panel, it will automatically switch on with the last setting activated (radio, CD/MP3, CD changer or AUX) when the panel is replaced.

Switching on/off

There are various ways of switching the device on/off:

Switching on/off using the vehicle ignition

The device will switch on/off simultaneously with the ignition if the device is correctly connected to the vehicle's ignition and you did not switch the device off by pressing button ①.

Switching the device on/off using the detachable control panel

- ⇒ Detach the control panel.

The device switches off automatically after approx. one minute.

- ⇒ Attach the control panel again.

The device switches on. The last setting (radio, CD, CD changer or AUX) will be reactivated.

Switching on/off using button ①

- ⇒ To switch on the device, press button ①.
- ⇒ To switch off the device, press and hold down button ① for longer than two seconds.

The device switches off.

Note:

- To protect the vehicle battery, the device will switch off automatically after one hour if the ignition is off.

Adjusting the volume

You can adjust the volume in steps from 0 (off) to 50 (maximum).

To increase the volume,

- ⇨ turn the volume control ⑤ clockwise.

To decrease the volume,

- ⇨ turn the volume control ⑤ anticlockwise.

Setting the power-on volume

You can set the default volume level at which the device plays when it is switched on.

- ⇨ Press the **MENU** button ⑨.
- ⇨ Press the **↵** or **↶** button ⑦ repeatedly until "VOLUME MENU" appears in the display.
- ⇨ Press the **OK** button ⑩ to display the volume menu.

"LAST VOLUME" and the currently set value are displayed or "ON VOLUME" is displayed.

- ⇨ Adjust the power-on volume using the **←>** buttons ⑦.

To help you adjust the setting more easily, the device will increase or decrease the volume as you make your changes.

If you change the setting to "LAST VOLUME", the volume when the device switches on will be the same as the volume level that was set the last time you switched the device off.

 Risk of injury! If the power-on volume is set to maximum, the volume level can be very high when the device is switched on.

If the volume was set to maximum before the device was switched off and the power-on volume is set to "LAST VOLUME", the volume level can be very high when the device is switched on again.

Severe damage to your hearing can be caused in both cases!

When you have finished making your changes,

- ⇨ press the **MENU** button ⑨.

Instantaneously decreasing the volume (mute)

You can instantaneously decrease the volume (mute) to a level preset by you.

- ⇨ **Briefly** press button ①.

"MUTE" appears in the display.

Cancelling mute

To return to your previously set volume level,

- ⇨ **briefly** press button ① again.

Telephone audio / navigation audio

If your car sound system is connected to a mobile telephone or a navigation system, the sound system's volume will be muted as soon as you "pick up" the phone or as soon as a navigation announcement is made. You will then hear the caller or navigation announcement over the car sound system's loudspeaker.

ADJUSTING THE VOLUME

ers. In order for this feature to work, the mobile telephone or navigation system must be connected to the car sound system as described in the installation instructions.

You will need a cable for this with the following Blaupunkt number: 7 607 001 503.

You can find out from your Blaupunkt dealer which navigation systems can be used with your car sound system.

If the sound system receives a traffic announcement during a telephone call or whilst a navigation announcement is being made, you will only be able to hear the traffic announcement after the call or navigation announcement is finished (in so far as the traffic announcement is still being broadcast). The traffic announcement is not recorded!

You can set the volume level at which telephone calls and navigation announcements will initially be heard.

- ⇨ Press the **MENU** button (9).
- ⇨ Press the **↵** or **↶** button (7) repeatedly until "VOLUME MENU" appears in the display.
- ⇨ Press the **OK** button (10) to display the volume menu.
- ⇨ Press the **↵** or **↶** button (7) repeatedly until "PHONE/NAVI" appears in the display.
- ⇨ Set your preferred volume level using the **◀▶** buttons (7).

When you have finished making your changes,

- ⇨ press the **MENU** button (9).

Note:

- You can use the volume control (5) to adjust the volume of telephone calls and navigation announcements whilst you are listening to them.

Setting the volume of the confirmation beep

The system will output a confirmation beep for some functions if you keep a button pressed down for longer than two seconds, for instance, when assigning a radio station to a station preset button. You can adjust the volume of this beep.

- ⇨ Press the **MENU** button (9).
- ⇨ Press the **↵** or **↶** button (7) repeatedly until "VOLUME MENU" appears in the display.
- ⇨ Press the **OK** button (10) to display the volume menu.
- ⇨ Press the **↵** or **↶** button (7) repeatedly until "BEEP VOL" appears in the display.
- ⇨ Adjust the volume using the **◀▶** buttons (7). "0" means that the beep is deactivated, "6" means that the maximum beep volume is set.

When you have finished making your changes,

- ⇨ press the **MENU** button (9).

Automatic sound

This feature automatically adjusts the volume of the car sound system to suit the speed at which the vehicle is travelling. In order for this to work, your car sound system must be connected as described in the installation instructions.

You can adjust the automatic volume boost feature in six steps from (0 to 5).

- ⇨ Press the **MENU** button (9).
- ⇨ Press the **↵** button (7) repeatedly until "VOLUME MENU" appears in the display.
- ⇨ Press the **OK** button (10) to display the volume menu.
- ⇨ Press the **↵** or **↶** button (7) repeatedly until "AUTO SOUND" appears in the display.
- ⇨ Set the volume adjustment level (0 - 5) using the **←→** buttons (7).

When you have finished making your changes,

- ⇨ press the **MENU** button (9).

Note:

- The optimum setting (0 - 5) for the speed-dependent volume adjustment feature depends on how noise levels develop in your particular vehicle. You will need to test various settings in order to find out which is best suited to your vehicle.

Radio mode

This device is equipped with an RDS radio receiver. Many of the receivable FM stations broadcast a signal that not only carries the programme but also additional information such as the station name and programme type (PTY).

The station name appears in the display as soon as the tuner receives it.

Switching to radio mode

If you are in CD, CD changer or AUX mode,

- ⇨ press the **BND•TS** button (4).

or

- ⇨ press the **SRC** button (16) repeatedly until the memory bank (e.g. "FM1") appears in the display.

Convenient RDS functions (AF, REG)

The convenient RDS functions AF (Alternative Frequency) and REGIONAL extend your radio's range of functions.

- **AF:** If the RDS function is activated, the radio automatically tunes into the best receivable frequency for the station that is currently set.
- **REGIONAL:** At certain times, some radio stations divide their programme into regional programmes providing different content. You can use the REG function to prevent the car radio from switching to alternative frequencies that are transmitting different programme content.

RADIO MODE

Note:

- REGIONAL must be activated/de-activated separately in the menu.

Switching REGIONAL on/off

- ⇒ Press the **MENU** button (9).
- “TUNER MENU” appears in the display.
- ⇒ Press the **OK** button (10) to display the tuner menu.
 - ⇒ Press the **↵** or **↶** button (7) repeatedly until “REG” appears in the display. “OFF” or “ON” is displayed alongside “REG”.
 - ⇒ To switch REGIONAL on/off, press the **↵** or **↶** button (7).
 - ⇒ Press the **MENU** button (9).

Switching the RDS function on/off

If you want to use the RDS functions (AF and REGIONAL),

- ⇒ press the **RDS** button (3).

The RDS functions are active when RDS lights up in the display.

Selecting the waveband / memory bank

This device can receive programmes broadcast over the FM frequency range as well as the MW and LW (AM) wavebands. There are three memory banks available for the FM waveband (FM1, FM2 and FMT) and one for each of the MW and LW wavebands.

Six stations can be stored in each memory bank.

To switch between the FM memory banks (FM1, FM2 and FMT) and the MW and LW wavebands,

- ⇒ briefly press the **BND•TS** button (4).

Tuning into a station

There are various ways of tuning into a station.

Automatic station seek tuning

- ⇒ Press the **↵** or **↶** button (7).

The radio tunes into the next receivable station.

Tuning into stations manually

You can also tune into stations manually.

Note:

- You can only tune into stations manually if the RDS function is de-activated.
- ⇒ Press the **↵** or **↶** button (7).

Browsing through broadcasting networks (only FM)

If a radio station provides several programmes, you have the option of browsing through its so-called “broadcasting network”.

Note:

- The RDS function must be activated before you can use this feature.
- ⇒ Press the **↵** or **↶** button (7) to switch to the next station on the broadcasting network.

Note:

- When using this feature, you will only be able to switch to stations that you have received once before already. To receive the stations, use the Scan or Travelstore function.

Setting the sensitivity of station seek tuning

You can choose whether the radio should only tune into stations providing good reception or whether it can also tune into those with a weak reception.

- ⇒ Press the **MENU** button (9).

“TUNER MENU” appears in the display.

- ⇒ Press the **OK** button (10) to display the tuner menu.

- ⇒ Press the **↔** or **↔** button (7) repeatedly until “SENS” appears in the display.

The display shows the currently set sensitivity level. “SENS HI3” means that the tuner is set to the highest sensitivity setting. “SENS LO1” means it is set to the lowest sensitivity setting.

- ⇒ Set the sensitivity level that you want using the **←→** buttons (7).

When you have finished making your changes,

- ⇒ press the **MENU** button (9).

Note:

- You can set different sensitivity levels for FM and MW or LW (AM).

Storing stations

Storing stations manually

- ⇒ Select the memory bank that you want (FM1, FM2, FMT) or one of the wavebands (MW or LW).
- ⇒ Tune into the station that you want.
- ⇒ Press and hold down one of the station buttons **1 - 3** (6) or **4 - 6** (11) for longer than two seconds to assign the station to that button.

Storing stations automatically (Travelstore)

You can automatically store the six stations providing the best reception in the region (only FM). The stations are stored in the FMT memory bank.

Note:

- Any stations that were previously stored in this memory bank are deleted in the process.
- ⇒ Press and hold down the **BND•TS** button (4) for longer than two seconds.

The storing procedure begins. “TRAVEL STORE” appears in the display. After the process has completed, the radio will play the station that is stored in memory location 1 of the FMT memory bank.

Listening to stored stations

- ⇒ Select the memory bank or waveband.
- ⇒ Press the station button **1 - 3** (6) or **4 - 6** (11) that the station you want to listen to is assigned to.

RADIO MODE

Scanning receivable stations (SCAN)

You can use the scan function to play all the receivable stations briefly. You can set the scanning time in the menu to between 5 and 30 seconds.

Starting SCAN

- ⇒ Press and hold down the **OK** button (10) for longer than two seconds.

Scanning begins. "SCAN" appears briefly in the display followed by a flashing display of the current station name or frequency.

Cancelling SCAN and continuing listening to a station

- ⇒ Press the **OK** button (10).

Scanning stops and the radio continues playing the station that it tuned into last.

Setting the scanning time

- ⇒ Press the **MENU** button (9).

"TUNER MENU" appears in the display.

- ⇒ Press the **↵** or **↶** button (7) repeatedly until "VARIOUS MENU" appears in the display.

- ⇒ Press the **OK** button (10) to display the menu.

"SCAN TIME" and the currently set time are displayed.

- ⇒ Set the scanning time that you want using the **←>** buttons (7).

When you have finished making your changes,

- ⇒ press the **MENU** button (9).

Note:

- The scanning time that you set is also applied by the system to scanning carried out in CD/MP3 mode and CD-changer mode.

Programme type (PTY)

Besides transmitting the station name, some FM stations also provide information on the type of programme that they are broadcasting. Your car radio can receive and display this information.

For example, the programme types can be:

CULTURE	TRAVEL	JAZZ
SPORT	NEWS	POP
ROCK	CLASSICS	

You can use the PTY function to select stations of a particular programme type.

PTY-EON

If you specify the programme type and start seek tuning, the radio will switch from the current station to a station of the selected programme type.

Note:

- If the tuner does not find a station that corresponds to the selected programme type, you will hear a beep and "NO PTY" appears briefly in the display. The radio will then retune to the station that it received last.
- If the tuned radio station or another station on the broadcasting network broadcasts your selected programme type at a later point in time, the radio will automatically switch from the currently tuned sta-

tion or from CD/MP3 mode or CD-changer mode to the station whose programme type matches the one you selected.

Switching PTY on/off

- ⇒ Press the **MENU** button (9).
- “TUNER MENU” appears in the display.
- ⇒ Press the **OK** button (10) to display the tuner menu.
- “PTY” and the current setting appear in the display.

- ⇒ Press the **◀** or **▶** button (7) to switch PTY ON or OFF.
- ⇒ Press the **OK** button (10).

Selecting a programme type and starting seek tuning

- ⇒ Press the **◀** or **▶** button (7).
- The current programme type appears in the display.

- ⇒ If you want to select another programme type, you can do so by pressing the **◀** or **▶** button (7) whilst this display is visible.

Or

- ⇒ Press one of the buttons **1 - 3** (6) or **4 - 6** (11) to select a programme type that is assigned to one of these buttons.

The selected programme type appears briefly in the display.

- ⇒ Press the **⏮** or **⏭** button (7) to start seek tuning.

The radio will then tune into the next station that it finds that corresponds to your selected programme type.

Assigning a programme type to a station button

- ⇒ Select a programme type using the **◀** or **▶** button (7).
- ⇒ Press and hold down the station button **1 - 3** (6) or **4 - 6** (11) that you want for longer than two seconds.

The programme type will then be assigned to the selected button **1 - 3** (6) or **4 - 6** (11).

Optimising radio reception

Treble reduction feature during interference (HICUT)

The HICUT function improves reception during poor radio reception (only FM). If interference occurs, the system automatically reduces the treble thus reducing the interference level.

Switching HICUT on/off

- ⇒ Press the **MENU** button (9).
- “TUNER MENU” appears in the display.
- ⇒ Press the **OK** button (10) to display the tuner menu.
- ⇒ Press the **⏮** or **⏭** button (7) repeatedly until “HICUT” appears in the display.
- ⇒ Press the **◀** or **▶** button (7) to adjust the HICUT setting.

“HICUT 0” means that no automatic reduction of the interference level will be made; “HICUT 2” means that a maximum reduction will be made.

- ⇒ Press the **MENU** button (9).

RADIO MODE

Switching bandwidth during interference (SHARX)

The SHARX function allows you to largely avoid interference caused by neighbouring radio stations (FM only). Switch on the SHARX function if the density of radio stations in your area is very high.

Switching SHARX on/off

- ⇨ Press the **MENU** button (9).
- “TUNER MENU” appears in the display.
- ⇨ Press the **OK** button (10) to display the tuner menu.
- ⇨ Press the **↵** or **↶** button (7) repeatedly until “SHARX” appears in the display.
- ⇨ Press the **↩** or **↷** button (7) to switch SHARX on/off.

“SHARX OFF” means automatic bandwidth switching is deactivated, “SHARX ON” means it is activated.

- ⇨ Press the **MENU** button (9).

Configuring the display

You have the option in radio mode of displaying the frequency / radio text or the frequency / radio text and the time in the lower display area. You can also make the system show just the station name (if receivable) in the entire display.

- ⇨ Briefly press the **DIS•ESC** button (8) to switch between the options.

Naming radio stations (only FM)

This device allows you to give stored radio stations their own name. The name can be up to eight characters long. This name is displayed in the second line of the display beneath the frequency. You can only give stations a name that you have stored together with their frequency and which do not already have their own RDS name.

- ⇨ Press the **MENU** button (9).
- “TUNER MENU” appears in the display.
- ⇨ Press the **OK** button (10) to display the tuner menu.
- ⇨ Press the **↵** or **↶** button (7) repeatedly until “STATION NAME” appears in the display.
- ⇨ Press the **↷** button (7).

You will now enter editing mode. The currently set name is displayed and the first text input position flashes.

- ⇨ Use the **↵** / **↶** buttons (7) to select the character that you want. If you want an empty space, simply select the underscore.
- ⇨ Use the **↩** or **↷** button (7) to move from one text input position to another.
- ⇨ Press the **MENU** button (9).

Activating/deactivating the radio text display

Some stations use the RDS signal to broadcast scrolling texts known as radio texts. You can allow radio texts to be displayed or you can block them.

- ⇒ Press the **MENU** button (9).
- “TUNER MENU” appears in the display.
- ⇒ Press the **OK** button (10) to display the tuner menu.
 - ⇒ Press the **↵** or **↶** button (7) repeatedly until “R-TEXT” appears in the display.
 - ⇒ Press the **↵** or **↶** button (7) to switch radio text on/off.
- “R-TEXT OFF” means that no radio texts will be displayed and “R-TEXT ON” means they will be displayed.
- ⇒ Press the **MENU** button (9).

Traffic information

Your device is equipped with an RDS-EON receiver. EON stands for **Enhanced Other Network**.

Whenever a traffic announcement (TA) is broadcast, the system switches automatically from a station that does not provide traffic reports to the appropriate traffic information station within the broadcasting network that does.

Once the traffic report has been played, the system will switch back to the programme that you were listening to before.

Switching traffic information priority on/off

- ⇒ Press the **TRAF** button (13).

Traffic announcement priority is active when the traffic-jam symbol lights up in the display.

Note:

You will hear a warning beep:

- if you leave the reception area of a traffic information station that you are currently listening to.
- if, while listening to a CD or CD in the changer, you leave the reception area of a traffic information station that the system is tuned into and the subsequent automatic search cannot find a new traffic information station.
- if you retune the radio from a traffic information station to a station that does not broadcast traffic information.

If you hear the warning beep, you can either switch off traffic information priority or tune into a station that broadcasts traffic information.

Setting the volume for traffic announcements

- ⇒ Press the **MENU** button (9).
- ⇒ Press the **↵** or **↶** button (7) repeatedly until "VOLUME MENU" appears in the display.
- ⇒ Press the **OK** button (10) to display the volume menu.
- ⇒ Press the **↵** or **↶** button (7) repeatedly until "TRAFFIC" appears in the display.
- ⇒ Adjust the volume using the **←>** buttons (7).

When you have finished making your changes,

- ⇒ press the **MENU** button (9).

Note:

- Using the volume control (5), you can also adjust the volume during a traffic announcement for the duration of that announcement.

Note:

- You can adjust the sound settings and volume distribution settings for traffic announcements. For further information, please read the "Sound" chapter.

CD mode

You can use this device to play standard audio CDs, CD-Rs and CD-RWs with a diameter of 12 cm. To avoid problems when playing CDs, you should not burn CDs at speeds greater than 16-speed.

Besides being able to play audio CDs on this device, you can also play CDs containing MP3 music files. For further information, please read the chapter entitled "MP3 mode".



Risk of severe damage to the CD drive!

CD singles with a diameter of 8 cm and non-circular contoured CDs (shape CDs) must not be used.

We accept no responsibility for any damage to the CD drive that may occur as a result of the use of unsuitable CDs.

Switching to CD mode

- If there is no CD inserted in the drive,
- ⇒ press the **▶** button (2).

The flip-release panel opens.

- ⇒ Gently insert the CD with its printed side uppermost into the drive until you feel some resistance.

The drive draws in the CD automatically.

You must not hinder or assist the drive as it draws in the CD.

- ⇒ Gently close the control panel whilst exerting a little pressure until you feel it click into place.

The CD starts playing.



Note:

- If the device was switched off before you inserted the CD, you will first have to switch on the device by pressing button (1) in order to start playing the CD.
 - If a CD is already inserted in the drive,
- ⇒ press the **SRC** button (16) repeatedly until "CD" appears in the display.

Playback begins from the point at which it was last interrupted.



Selecting tracks

- ⇒ Press one of the arrow buttons (7) to select the next or previous track.

If you press the  or  button (7) once, the player will play the current track again from the beginning.



Fast track selection

To quickly select tracks backwards or forwards,

- ⇒ press and hold down one of the  /  buttons (7) until fast-reverse / fast-forward track selection begins.

Fast searching (audible)

To fast search backwards or forwards,

- ⇒ press and hold down one of the   buttons (7) until fast searching backwards / forwards begins.

Random track play (MIX)

- ⇒ Press the **4 MIX** button (11).

"MIX CD ON" appears briefly in the display and the MIX symbol lights up. The next randomly selected track will then be played.

Cancelling MIX

- ⇒ Press the **4 MIX** button (11) again.

"MIX CD OFF" appears briefly in the display and the MIX symbol disappears.

Scanning tracks (SCAN)

You can scan (briefly play) all the tracks on the CD.

- ⇒ Press and hold down the **OK** button (10) for longer than two seconds.

The next track will then be scanned.

Note:

- You can set the scanning time. For further information, please read the section entitled "Setting the scanning time" in the "Radio mode" chapter.

Cancelling SCAN and continuing listening to a track

- ⇒ To stop scanning, press the **OK** button (10).

The currently scanned track will then continue to be played normally.

CD MODE

Repeating tracks (REPEAT)

If you want to repeat a track,

⇒ press the **5 RPT** button (11).

“RPT TRK ON” appears briefly in the display and the RPT symbol lights up. The track is repeated continuously until you deactivate RPT.

Cancelling REPEAT

If you want to cancel the repeat function,

⇒ press the **5 RPT** button (11) again.

“RPT TRK OFF” appears briefly in the display and the RPT symbol disappears. Normal playback is then resumed.

Pausing playback (PAUSE)

⇒ Press the **6**  button (11).

“PAUSE” appears in the display.

Cancelling pause

⇒ Press the **6**  button (11) while in pause mode.

Playback is resumed.

Changing the display

You can choose from various display options in CD mode:

- “NORMAL MODE”:
First line: Track number
Second line: Playing time
- “INFO MODE”:
First line: Track number and playing time.
Second line: CD text or CD name

- “CLOCK TIME”:
First line: Track number and playing time.
Second line: CD text or CD name and clock time

Note:

- In the menu you can configure whether you want to display the CD text or the CD name. For further information, please read the following section entitled “Displaying CD text”.
- CD text can only be displayed if the appropriate information is contained on the CD. The CD name can only be displayed if you have already named the CD. For further information, please read the section entitled “Naming CDs”.

To switch between the display options,

⇒ press the **DIS•ESC** button (8) once or several times until the display that you want appears.

Displaying CD text/CD name

Some CDs include CD text. The CD text might contain the names of the artist, album and tracks.

The CD text is displayed in the second line of the display instead of the CD name. You can allow the CD text to be displayed as scrolling text every time you switch to another track. The default display will appear again after the whole CD text has been shown once. For further information, please read the section entitled “Changing the display”.

Switching CD text on/off

- ⇒ Press the **MENU** button (9).
- ⇒ Press the **↵** or **↶** button (7) repeatedly until "VARIOUS MENU" appears in the display.
- ⇒ Press the **OK** button (10).
- ⇒ Press the **↵** or **↶** button (7) repeatedly until "CD TEXT" or "CD NAME" appears in the display.
- ⇒ Use the **←** / **→** buttons (7) to switch between the "CD TEXT" and "CD NAME" options.

When you have finished making your changes,

- ⇒ press the **MENU** button (9).

Scrolling CD text

If the CD that is inserted in the drive contains CD text, you can make the system display the text as scrolling text during playback.

- ⇒ Briefly press the **1 SCL** button (6).

Naming CDs

The car sound system allows you to assign names for up to 30 CDs so that you can recognise them more easily. The names can be up to eight characters long. "CD NAME FULL" will appear in the display if you try assigning more than 30 names.

Entering/editing CD names

- ⇒ Listen to the CD that you want.
- ⇒ Press the **MENU** button (9).
- ⇒ Press the **↵** or **↶** button (7) repeatedly until "VARIOUS MENU" appears in the display.
- ⇒ Press the **OK** button (10).
- ⇒ Press the **↵** or **↶** button (7) repeatedly until "CD NAME EDIT" appears in the display.
- ⇒ Press the **OK** button (10).

You will now enter editing mode. If your CD does not have a name yet, "ABC-DEFGH" appears in the display. The first text input position flashes.

- ⇒ Use the **↵** / **↶** buttons (7) to select the character that you want. If you want an empty space, simply select the underscore.
- ⇒ Use the **←** or **→** button (7) to move from one text input position to another.

When you have finished making your changes,

- ⇒ press the **OK** button (10).

Deleting a CD name

- ⇒ Listen to the CD whose name you want to delete.
- ⇒ Press the **MENU** button (9).
- ⇒ Press the **↵** or **↶** button (7) repeatedly until "VARIOUS MENU" appears in the display.
- ⇒ Press the **OK** button (10).

CD MODE

⇨ Press the **↵** or **↶** button (7) repeatedly until “CD NAME EDIT” appears in the display.

⇨ Press the **OK** button (10).

⇨ Press and hold down the **MENU** button (9). After four seconds you will hear a beep and “DELETE NAME” appears in the display.

⇨ Let go of the **MENU** button (9).

The CD name will be deleted.

⇨ You can return to the menu by pressing the **MENU** button (9).

Deleting all CD names

You can delete all the CD names stored in the car sound system.

⇨ Listen to a CD.

⇨ Press the **MENU** button (9).

⇨ Press the **↵** or **↶** button (7) repeatedly until “VARIOUS MENU” appears in the display.

⇨ Press the **OK** button (10).

⇨ Press the **↵** or **↶** button (7) repeatedly until “CD NAME EDIT” appears in the display.

⇨ Press the **OK** button (10).

⇨ Press and hold down the **MENU** button (9). After four seconds you will hear a beep and “DELETE NAME” appears in the display. Continue holding the button pressed down until you hear a second beep and “DELETE ALL” appears in the display.

⇨ Let go of the **MENU** button (9).

The CD names will be deleted.

⇨ You can return to the menu by pressing the **MENU** button (9).

Traffic announcements in CD mode

If you wish to receive traffic announcements in CD mode,

⇨ press the **TRAF** button (13).

Traffic announcement priority is active when the traffic-jam symbol lights up in the display. For further details, please read the chapter entitled “Traffic information”.

Ejecting a CD

⇨ Press the **⏏** button (2).

The flip-release panel opens out towards you.

⇨ Press the eject button (17) next to the CD compartment.

The CD is ejected.

⇨ Remove the CD and close the control panel.

Note:

- If a CD is ejected, the drive will automatically draw it back in again after 10 seconds.
- You can also eject CDs whilst the device is switched off or whilst another audio source is activated.

MP3 mode

You can also use this car sound system to play CD-Rs and CD-RWs that contain MP3 music files.

MP3 is a process developed by the Fraunhofer Institute for compressing CD audio data. Compression allows data to be reduced to around 10% of their original size without a noticeable loss in quality (at a bit rate of 128 kbit/s). If a lower bit rate is used to convert CD audio data to MP3, you will be able to create smaller files but this will be accompanied by a loss in audio quality.

Preparing an MP3-CD

The various combinations of CD burners, CD burning software and CD blanks may lead to problems arising with the device's ability to play certain CDs. If problems occur with your own burned CDs, you should try another brand of CD blank or choose another colour of CD blank. To avoid problems when playing CDs, you should not burn CDs at speeds greater than 16-speed.

The format of the CD must be ISO 9660 Level 1 / Level 2 or Joliet. Other formats cannot be played reliably.

You can create a maximum of 253 directories on a CD. You can use this device to access each of these directories.

Regardless of the number of directories on the CD, the device can handle up to 65,535 MP3 files on a single CD - even if they are all stored in one directory.

This device supports as many subdirectories as your burner software can create despite the fact that the maximum directory depth defined by the ISO 9660 standard is only 8.

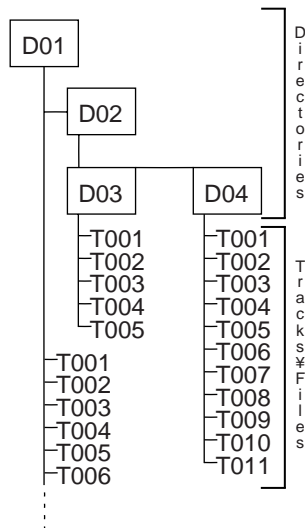

You can name each directory using a PC. The device is capable of displaying the directory name. Name the directories and tracks/files using your CD burner software. The software's instruction manual will provide details on how to do this.

MP3 MODE

Note:

- When naming directories and tracks/files you should avoid using accents and special characters. You can use a maximum of 32 characters (including the “.MP3” file extension) for track names and directory names.

If you like your files to be in the correct order, you should use burner software that places files in alphanumerical order. If your software does not provide this feature you also have the option of sorting the files manually. To do so, you should place a number (e.g. “001”, “002”, etc.) at the beginning of each file name - you must include the leading zeros.

MP3 tracks can contain additional information such as the artist, album and track names (ID3 tags). This device can display ID3 tags (version 1). When creating (encoding) MP3 files from audio files, you should use bit rates up to a maximum of 256 kbits/sec.

This device can only play MP3 files that have the “.MP3” file extension.

Notes:

To ensure uninterrupted playback,

- do not try changing the file extension to “.MP3” of any files other than MP3 files and then attempt to play them! The device will ignore these invalid files during playback.
- Do not use “mixed” CDs containing both non-MP3 data and MP3 tracks (the device only reads MP3 files during MP3 playback).

- Do not use mix-mode CDs containing both CD-audio tracks and MP3 tracks. If you try playing a mix-mode CD, the device will only play the CD-audio tracks.

Switching to MP3 mode

MP3 mode is activated in the same way as normal CD mode. For further information, please read the section entitled “Switching to CD mode” in the “CD mode” chapter.

Configuring the display

Configuring the default display

You can display various types of information on the current track:

1. “NORMAL MODE”:
First line: Track name
Second line: Directory name
2. “INFO MODE”:
First line: Track name.
Second line: MP3-ID TAG (if available and activated, see “Selecting MP3 info”).

Note:

- The system can display MP3-ID tags (version 1) if they have been saved with the MP3 files (for further information, please read the instructions that came with your PC’s MP3 software or burner software).
3. “MP3 BROWSE MODE”:
First line: Directory name
Second line: Track name.

Note:

- You can use MP3 browse mode to find MP3 files on your CD quickly and conveniently. You cannot use the fast search, MIX, SCAN or REPEAT functions whilst in MP3 browse mode.

4. "TRACK AND DIR MODE":

First line: Track number and play-time.

Second line: Directory number

5. "CLOCK MODE":

First line: Directory number and track number.

Second line: CD text or CD name and clock time

To switch between the different display options,

- press the **DIS•ESC** button (8).

Selecting a directory**Selecting a directory using the arrow buttons (Normal, info, track and dir and clock mode)**

To move up or down to another directory,

- press the **↖** or **↗** button (7) once or several times.

Note:

- The device will automatically skip any directories that do not contain MP3 files. The device will automatically correct the number of directories for the display. This number might therefore no longer be identical to the number of directories that you actually created.

Selecting the directory in browse mode

You can display the current and subsequent directory in both lines of the display. The directories are displayed with the names that you created when burning the CD. Whilst the directories are being displayed, you can use the arrow buttons to display and select all the available directories.

- During MP3 playback, press the **DIS•ESC** button (8) repeatedly until "MP3 BROWSE MODE" appears in the display.
- Press the **↖** or **↗** button (7) to display the directories on the CD.
- If you want to select a directory, press one of the **↖** / **↗** buttons (7) repeatedly until the directory is shown in the **top** line of the display and then press the **OK** button (10).

The selected directory opens and the first track starts playing. The tracks contained in the directory are displayed in browse mode.

MP3 MODE

Selecting tracks

Selecting tracks/files using the arrow buttons (Normal, info, track and dir and clock mode)

To move up or down to another track/file in the current directory,

⇨ press the **◀** or **▶** button (7) once or several times.

If you press the **◀** button (7) once, the current track will be played again from the beginning.

Selecting tracks in browse mode

Browse mode conveniently allows you to view the tracks contained in a directory and then select a particular track.

⇨ During MP3 playback, repeatedly press the **DIS•ESC** button (8) until "MP3 BROWSE MODE" is displayed.

⇨ Press the **◀** or **▶** button (7) to display all the tracks contained in the directory one after another.

⇨ If you want to select the currently displayed track, press the **OK** button (10).

Fast searching

(not in MP3 browse mode)

To fast search backwards or forwards,

⇨ press and hold down the **◀** or **▶** button (7) until fast searching backwards / forwards begins.

Random track play – MIX (not in MP3 browse mode)

To play the tracks in the current directory in random order,

⇨ briefly press the **4 MIX** button (11).

"MIX DIR" appears in the display and the MIX symbol lights up.

To play the tracks contained in all the directories on the inserted MP3-CD in random order,

⇨ press the **4 MIX** button (11) again.

"MIX CD" appears in the display and the MIX symbol lights up.

Cancelling MIX

To cancel MIX,

⇨ briefly and repeatedly press the **4 MIX** button (11) until "MIX OFF" appears in the display.

The MIX symbol disappears.

Scanning tracks – SCAN (not in MP3 browse mode)

You can scan (briefly play) all the tracks on the CD.

⇨ Press and hold down the **OK** button (10) for longer than two seconds. The next track will then be scanned.

"SCAN" and the selected display mode appear alternately in the display (see "Configuring the display").

Note:

- You can set the scanning time. For further information on setting the scanning time, please read the

section entitled “Setting the scanning time” in the “Radio mode” chapter.

Cancelling SCAN and continuing listening to a track

⇒ Briefly press the **OK** button (10).

The currently scanned track will then continue to be played normally.

Repeating individual tracks or whole directories – REPEAT (not in MP3 browse mode)

To play the current track repeatedly,

⇒ briefly press the **5 RPT** button (11).

“REPEAT TRACK” appears briefly in the display and RPT lights up.

To repeat the whole directory,

⇒ press the **5 RPT** button (11) again.

“REPEAT DIR” appears briefly in the display.

Cancelling REPEAT

To stop the current track or current directory from being repeated,

⇒ briefly and repeatedly press the **5 RPT** button (11) until “REPEAT OFF” appears in the display.

RPT disappears from the display.

Pausing playback (PAUSE)

⇒ Press the **6 |||** button (11).

“PAUSE” appears in the display.

Cancelling pause

⇒ Press the **6 |||** button (11) while in pause mode.

Playback is resumed.

Selecting MP3 info

If you want to select the “MP3 INFO” display mode, you first have to activate this function in the menu.

In order for the system to be able to display MP3 information, the information must be stored on the CD in the form of ID tags together with the MP3 files.

⇒ Press the **MENU** button (9).

⇒ Press the **↵** or **↶** button (7) repeatedly until “VARIOUS MENU” appears in the display.

⇒ Press the **OK** button (10).

⇒ Press the **↵** or **↶** button (7) repeatedly until “MP3 INFO” appears in the display.

⇒ Use the **←** **→** buttons (7) to switch between the “ON” and “OFF” options.

When you have finished making your changes,

⇒ press the **MENU** button (9).

Displaying scrolling text

The selected information (track, album or file name and directory name) is displayed once as scrolling text when the track changes. To display the information again as scrolling text,

⇒ briefly press the **1 SCL** button (6).

CD CHANGER MODE

CD-changer mode

Note:

- Information on handling CDs, inserting CDs and operating the CD changer can be found in the operating instructions supplied with your CD changer.

Switching to CD-changer mode

- ⇒ Press the **SRC** button (16) repeatedly until “CDC” appears in the display.

The device starts playing the first CD that the CD changer detects.

Selecting CDs

To move up or down to another CD,

- ⇒ press the **↕** or **↔** button (7) once or several times.

Note:

- The device will ignore empty CD slots in the changer and slots containing invalid CDs.

Selecting tracks

To move up or down to another track on the current CD,

- ⇒ press the **◀** or **▶** button (7) once or several times.

Fast searching (audible)

To fast search backwards or forwards,

- ⇒ press and hold down one of the **◀▶** buttons (7) until fast searching backwards / forwards begins.

Changing the display

You can choose from various display options in CD-changer mode:

- “NORMAL MODE”:
First line: Track number
Second line: CD number / CD name and playing time
- “CLOCK MODE”:
First line: Track number.
Second line: CD number / CD name and clock time
- “MINIMAL MODE”:
First and second line: Track number.

To switch between the display options,

- ⇒ press the **DIS•ESC** button (8).

In the menu you can choose to display the CD name (if available) instead of the CD number. (For further information, please read the “Naming CDs” section):

- ⇒ Press the **MENU** button (9).
- ⇒ Press the **↕** or **↔** button (7) repeatedly until “VARIOUS MENU” appears in the display.
- ⇒ Press the **OK** button (10).
- ⇒ Press the **↕** or **↔** button (7) repeatedly until “CD NAME” or “DISC NUMBER” appears in the display.
- ⇒ Use the **◀▶** buttons (7) to switch between the “CD NAME” and “DISC NUMBER” options.

When you have finished making your changes,

- ⇒ press the **MENU** button (9).

Repeating individual tracks or whole CDs (REPEAT)

To repeat the current track,

⇨ briefly press the **5 RPT** button (11).

“REPEAT TRACK” appears briefly and RPT lights up in the display.

To repeat the current CD,

⇨ press the **5 RPT** button (11) again.

“REPEAT CD” appears briefly and RPT lights up in the display.

Cancelling REPEAT

To stop the current track or current CD from being repeated,

⇨ repeatedly press button **5 RPT** (11) until “REPEAT OFF” appears in the display and RPT disappears.

Random track play (MIX)

To play the tracks on the current CD in random order,

⇨ briefly press the **4 MIX** button (11).

“MIX CD” appears briefly and MIX lights up in the display.

To play the tracks on all inserted CDs in random order,

⇨ press the **4 MIX** button (11) again.

“MIX ALL” appears briefly and MIX lights up in the display.

Cancelling MIX

⇨ Briefly and repeatedly press the **4 MIX** button (11) until “MIX OFF” appears in the display and MIX disappears.

Scanning all tracks on all CDs (SCAN)

To scan (briefly play) all the tracks on all the inserted CDs in ascending order,

⇨ press and hold down the **OK** button (10) for longer than two seconds.

“SCAN” and the selected display mode appear alternately in the display.

Stopping SCAN

To stop scanning,

⇨ briefly press the **OK** button (10).

The currently scanned track will then continue to be played normally.

Note:

- You can set the scanning time. For further information, please read the section entitled “Setting the scanning time” in the “Radio mode” chapter.

Pausing playback (PAUSE)

⇨ Press the **6** button (11).

“PAUSE” appears in the display.

Cancelling pause

⇨ Press the **6** button (11) while in pause mode.

Playback is resumed.

CD CHANGER MODE

Naming CDs

The car sound system allows you to assign names for up to 30 CDs so that you can recognise them more easily. The names can be a maximum of seven characters long.

“CD NAME FULL” will appear in the display if you try assigning more than 30 names.

Entering/editing CD names

- ⇒ Listen to the CD that you want.
- ⇒ Press the **MENU** button (9).
- ⇒ Press the **↵** or **↶** button (7) repeatedly until “VARIOUS MENU” appears in the display.
- ⇒ Press the **OK** button (10).
- ⇒ Press the **↵** or **↶** button (7) repeatedly until “CD NAME EDIT” appears in the display.
- ⇒ Press the **OK** button (10).

You will now enter editing mode. If your CD does not have a name yet, “ABC-DEFG” appears in the display. The currently active text input position flashes.

- ⇒ Use the **↵** / **↶** buttons (7) to select the character that you want. If you want an empty space, simply select the underscore.
- ⇒ Use the **←** or **→** button (7) to move from one text input position to another.

When you have finished making your changes,

- ⇒ press the **MENU** button (9).

Deleting a CD name

- ⇒ Listen to the CD whose name you want to delete.
- ⇒ Press the **MENU** button (9).
- ⇒ Press the **↵** or **↶** button (7) repeatedly until “VARIOUS MENU” appears in the display.
- ⇒ Press the **OK** button (10).
- ⇒ Press the **↵** or **↶** button (7) repeatedly until “CD NAME EDIT” appears in the display.
- ⇒ Press and hold down the **MENU** button (9). After four seconds you will hear a beep and “DELETE NAME” appears in the display.
- ⇒ Let go of the **MENU** button (9).
The CD name will be deleted.
- ⇒ You can return to the menu by pressing the **MENU** button (9).

Deleting all CD names

You can delete all the CD names stored in the car sound system.

- ⇒ Listen to a CD.
- ⇒ Press the **MENU** button (9).
- ⇒ Press the **↵** or **↶** button (7) repeatedly until “VARIOUS MENU” appears in the display.
- ⇒ Press the **OK** button (10).

- ⇨ Press the **↵** or **↶** button (7) repeatedly until “CD NAME EDIT” appears in the display.
- ⇨ Press and hold down the **MENU** button (9). After four seconds you will hear a beep and “DELETE NAME” appears in the display. Continue holding the button pressed down until you hear a second beep and “DELETE ALL” appears in the display.
- ⇨ Let go of the **MENU** button (9).
All CD names will be deleted.
- ⇨ Press the **OK** button (10) to return to the menu.

CLOCK time

Displaying the time

You can make the clock time appear continuously in the bottom part of the display while any audio source is activated. For further information, please read the “Configuring the display” sections in the relevant chapters.

Setting the clock automatically

You can configure the system to set the clock time automatically using the RDS signal.

- ⇨ Press the **MENU** button (9).
- ⇨ Press the **↵** or **↶** button (7) repeatedly until “CLOCK MENU” appears in the display.
- ⇨ Press the **OK** button (10).
- ⇨ Press the **↵** or **↶** button (7) repeatedly until “CLOCK AUTO” or “CLOCK MANUAL” appears in the display.
- ⇨ Select the “CLOCK AUTO” setting using the **←** or **→** button (7).
- ⇨ Press the **MENU** button (9).

The menu appears again.

Setting the clock manually

To set the clock time manually,

- ⇨ press the **MENU** button (9).
- ⇨ Press the **↵** or **↶** button (7) repeatedly until “CLOCK MENU” appears in the display.
- ⇨ Press the **OK** button (10).

CLOCK TIME

⇒ Press the **↵** or **↶** button (7) repeatedly until "CLOCK SET" appears in the display.

⇒ Press the **OK** button (10).

The time appears in the display.
The hours flash and can be adjusted.

⇒ Set the hours using the **↵** / **↶** buttons (7).

Once the hours are set,

⇒ press the **➤** button (7).

The minutes flash.

⇒ Set the minutes using the **↵** / **↶** buttons (7).

⇒ Press the **OK** button (10) and then the **MENU** button (9).

Selecting 12/24-hour clock mode

⇒ Press the **MENU** button (9).

⇒ Press the **↵** or **↶** button (7) repeatedly until "CLOCK MENU" appears in the display.

⇒ Press the **OK** button (10).

⇒ Press the **↵** or **↶** button (7) repeatedly until "24 HOUR MODE" or "12 HOUR MODE" appears in the display.

⇒ Press the **◀** or **➤** button (7) to switch between the modes.

When you have finished making your changes,

⇒ press the **MENU** button (9).

Displaying the time continuously when the device is off and the ignition is on

To display the time when the device is off and the vehicle ignition is on,

⇒ press the **MENU** button (9).

⇒ Press the **↵** or **↶** button (7) repeatedly until "CLOCK MENU" appears in the display.

⇒ Press the **OK** button (10).

⇒ Press the **↵** or **↶** button (7) repeatedly until "OFF CLOCK OFF" or "OFF CLOCK ON" appears in the display.

⇒ Press the **◀** or **➤** button (7) to switch between the ON/OFF settings.

When you have finished making your changes,

⇒ press the **MENU** button (9).

Sound

You can adjust the sound settings (bass and treble) separately for each source (radio, CD/MP3, CD changer, AUX, traffic announcement, telephone/navigation). The volume distribution settings (balance and fader) apply to all the audio sources.

Note:

- You can only adjust the audio settings for traffic announcements and the navigation system whilst a traffic announcement or navigation announcement is actually playing. Likewise, you can only adjust the telephone audio settings during a telephone call.

Adjusting the bass

- Press the **AUDIO** button (14).
"BASS" appears in the display.
- Press the **<** or **>** button (7) to adjust the bass.
- Press the **AUDIO** button (14) to close the menu or press the **↵** / **↶** button (7) to make further changes to the settings.

Adjusting the treble

- Press the **AUDIO** button (14).
- Press the **↵** or **↶** button (7) repeatedly until "TREBLE" appears in the display.
- Press the **<** or **>** button (7) to adjust the treble.
- Press the **AUDIO** button (14) to close the menu or press the **↵** / **↶**

button (7) to make further changes to the settings.

Setting the left/right volume distribution (balance)

To adjust the left/right volume distribution (balance),

- press the **AUDIO** button (14).
"BASS" appears in the display.
- Press the **↵** or **↶** button (7) repeatedly until "BALANCE" appears in the display.
- Press the **<** or **>** button (7) to adjust the balance (right/left).
- Press the **AUDIO** button (14) to close the menu or press the **↵** / **↶** button (7) to make further changes to the settings.

Adjusting the front/rear volume distribution (fader)

To adjust the front/rear volume distribution (fader),

- press the **AUDIO** button (14).
"BASS" appears in the display.
- Press the **↵** or **↶** button (7) repeatedly until "FADER" appears in the display.
- Press the **<** or **>** button (7) to adjust the fader (front/rear).
- Press the **AUDIO** button (14) to close the menu or press the **↵** / **↶** button (7) to make further changes to the settings.

X-BASS

The X-BASS feature can be used to boost the bass at low volume levels.

Adjusting the X-BASS boost

The X-BASS boost can be set in steps ranging from 1 to 6 for one of the following frequencies: 32 Hz, 40 Hz, 50 Hz, 63 Hz or 80 Hz.

“LEVEL 0” means that no X-BASS boost will be applied, and “LEVEL 6” means that X-BASS will be boosted by the maximum amount.

⇒ Press the **AUDIO** button (14).

“BASS” appears in the display.

⇒ Press the **↵** or **↶** button (7) repeatedly until “X-BASS” appears in the display.

⇒ Press the **OK** button (10).

The X-Bass menu is displayed. The frequency flashes.

⇒ Press the **↵** or **↶** button (7) to set the frequency that you want.

⇒ Press the **➤** button (7).

The boost level flashes.

⇒ Press the **↵** or **↶** button (7) to set the boost level that you want.

When you have finished making your changes,

⇒ press the **AUDIO** button (14).

Equalizer

The Casablanca MP54 is fitted with a digital DEQ Max equalizer. The Acapulco has a DEQ Max EX equalizer.

This means you have three 5-band equalizers, six sound presets and seven vehicle presets at your disposal.

You can also configure the EQ1 - EQ3 equalizers manually.

The Acapulco MP54 additionally allows you to calibrate an equalizer automatically. You can obtain the calibration microphone necessary for this from accessory retailers.

The following bands are available:

- LOW 1 20 - 250 Hz
- LOW 2 20 - 250 Hz
- HIGH 1 315 - 20 000 Hz
- HIGH 2 315 - 20 000 Hz
- HIGH 3 315 - 20 000 Hz

Switching the equalizer on/off

To switch the equalizer on/off,

⇒ press the **DEQ** button (15).

The equalizer menu appears in the display.

To activate the equalizer,

⇒ select one of the sound presets or adjust the equalizer manually. For further information, please read the sections that follow in this chapter.

To deactivate the equalizer,

- ⇒ press the **↵** or **↶** button (7) repeatedly until "EQ OFF" appears in the display.
- ⇒ Press the **OK** (10) button and then the **DEQ** button (15).

Selecting sound presets

You can select sound presets for the following music types.

- POP
- ROCK
- TECHNO
- JAZZ
- CLASSIC
- SPEECH

The settings for these music styles have already been programmed.

- ⇒ Press the **DEQ** button (15).
- ⇒ Press the **↵** or **↶** button (7) repeatedly until "SOUND PRESETS" appears in the display.
- ⇒ Press the **OK** button (10).
- ⇒ Repeatedly press the **↵** or **↶** button (7) until the sound preset that you want is displayed.
- ⇒ Press the **DEQ** button (15).

The settings are saved.

Selecting vehicle presets

You can choose from optimised equalizer settings for the following vehicle types.

- COMPACT
- 4DOOR
- CONVERT
- VAN
- ROADSTER
- MINI
- TRUCK

The settings for these vehicle types have already been programmed.

- ⇒ Press the **DEQ** button (15).
- ⇒ Press the **↵** or **↶** button (7) repeatedly until "CAR PRESETS" appears in the display.
- ⇒ Press the **OK** button (10).
- ⇒ Repeatedly press the **↵** or **↶** button (7) until the vehicle type that you want is displayed.
- ⇒ Press the **DEQ** button (15).

The settings are saved.

Automatic equalizer calibration (only Acapulco MP54)

You can electronically calibrate and store values for three different situations, e.g.:

- EQ 1 for the driver only
- EQ 2 for the driver and front passenger
- EQ 3 for the front and rear occupants

Hold the calibration microphone in the appropriate position whilst calibration is taking place.

EQUALIZER

The position of the calibration microphone for Situation 1 (e.g. for the driver alone) is at the height of the driver's head, approx. 10 cm next to the right ear.

For Situation 2, the calibration microphone should be positioned at head height between the driver and the front passenger.

For Situation 3, you should position the calibration microphone at head height in the centre of the vehicle interior (left/right, front/rear).

Really quiet surroundings are required for the calibration. Any extraneous noise will distort the measured values.

The windows, doors and sunroof must remain closed during the calibration process. You should be seated in the driving seat throughout this procedure.

Note:

You can obtain the calibration microphone necessary for this from accessory retailers.

During calibration, the temperature inside the vehicle must not exceed 55 °C since this could lead to falsified measurements.

The sound radiating from the loudspeakers must not be obstructed by any objects. All the loudspeakers must be connected. The microphone must be connected to the device.

To calibrate the automatic equalizer,

⇒ press the **DEQ** button (15).

⇒ Press the **↵** or **↶** button (7) repeatedly until "MANUAL EQ" appears in the display.

⇒ Press the **OK** button (10).

⇒ Press the **↵** or **↶** button (7) repeatedly until the equalizer that you want to calibrate ("USER EQ1", "USER EQ2" or "USER EQ3") appears in the display.

⇒ Press the **OK** button (10) twice.

⇒ Press the **ESC** button (8).

⇒ Press the **↵** or **↶** button (7) repeatedly until "AUTO EQ" appears in the display.

⇒ Press the **OK** button (10).

A countdown is shown in the display. Afterwards you will hear a test sound and calibration begins.

Note:

Follow the instructions shown in the display during calibration!

Manually adjusting the equalizer

Notes on adjusting the settings

We recommend you use a CD that you are familiar with for making changes to the settings.

Before adjusting the equalizer, set the sound and volume distribution settings to zero and deactivate X-BASS. For further information, please read the "Sound" chapter.

⇒ Listen to a CD.

⇒ What kind of impression does the sound make?

- ⇒ Now refer to the “Sound impression” column in the table entitled “Help adjusting the equalizer”.
- ⇒ Adjust the equalizer values as described in the “Measures” column.

Making adjustments

- ⇒ Press the **DEQ** button (15).
- ⇒ Press the **↵** or **↶** button (7) repeatedly until “MANUAL EQ” appears in the display.
- ⇒ Press the **OK** button (10).
- ⇒ Press the **↵** or **↶** button (7) repeatedly until the equalizer that you want to configure (“USER EQ1”, “USER EQ2” or “USER EQ3”) appears in the display.
- ⇒ Press the **OK** button (10).
- ⇒ Press the **↵** or **↶** button (7) repeatedly until the equalizer band that you want to configure (“LOW EQ1”, “LOW EQ2”, “HIGH EQ1”, “HIGH EQ2” or “HIGH EQ3”) appears in the display.
- ⇒ Press the **OK** button (10).
- ⇒ Press the **↵** or **↶** button (7) repeatedly until the frequency that you want is displayed.
- ⇒ Press the **OK** button (10).

The top line displays the GAIN and the quality factor “Q”. The gain setting flashes. You can use the quality factor to set the width of the filter. The higher you set the value for the quality factor the more directly the filter will be applied to the selected frequency.

To adjust the gain,

- ⇒ press the **↵** or **↶** button (7).

To adjust the quality factor,

- ⇒ press the **↶** button (7).

The quality factor setting flashes.

- ⇒ Press the **↵** or **↶** button (7) repeatedly until the setting that you want is displayed.

Note:

- Please note that you can boost or reduce one frequency in each equalizer band. Proceed in the way described above with all the equalizer bands that you want to adjust.
- ⇒ Press the **OK** button (10) or the **DEQ** button (15) to close the menu.

The settings are saved.

EQUALIZER

Help adjusting the equalizer

Sound Impression / problem	Measures
Bass sound is too weak	Increase bass with Frequency: 32 to 160 Hz Gain: +4 to +6 dB
Dirty bass Booming sound Unpleasant pressure	Reduce the lower mid level with Frequency: 400 Hz Gain: approx. -4 dB
Sound very much in the foreground, aggressive, no stereo effect.	Reduce the mid level with Frequency: 1,000 to 2,500 Hz Gain: -4 to -6 dB
Dull sound Little clarity No brilliance to the instruments	Boost the treble range with Frequency: 6,300 to 10,000 Hz Gain: +2 to +4 dB

Adjusting the display settings

Switching the bar graph on/off

You also have the option of switching off the bar graph in the bottom line of the display.

- ⇨ Press the **MENU** button (9).
- ⇨ Press the **↵** or **↶** button (7) repeatedly until "VARIOUS MENU" appears in the display.
- ⇨ Press the **OK** button (10).
- ⇨ Press the **↵** or **↶** button (7) repeatedly until "BARGRAPH" appears in the display alongside the current setting ("ON" or "OFF").
- ⇨ Press the **↵** or **↶** button (7) to switch between the ON and OFF settings.
- ⇨ Press the **MENU** button (9).

Switching the power meter on/off

The power meter (level display) in the bottom line of the display can be used indicate the relative output power of the car sound system (PWR METER ON) or the volume level (PWR METER OFF).

- ⇨ Press the **MENU** button (9).
- ⇨ Press the **↵** or **↶** button (7) repeatedly until "VARIOUS MENU" appears in the display.
- ⇨ Press the **OK** button (10).

- ⇨ Press the **↵** or **↶** button (7) repeatedly until "PWR METER" appears in the display alongside the current setting ("ON" or "OFF").
- ⇨ Press the **↵** or **↶** button (7) to switch between the settings.
- ⇨ Press the **MENU** button (9).

Adjusting the display brightness

The display brightness will change when the headlights are turned on/off if your car sound system is connected as described in the installation instructions and your vehicle is equipped with the appropriate connection. You can adjust the display brightness separately for night and day in steps ranging from 1 - 16.

- ⇨ Press the **MENU** button (9).
- ⇨ Press the **↵** or **↶** button (7) repeatedly until "DISPLAY MENU" appears in the display.
- ⇨ Press the **OK** button (10).
- ⇨ Press the **↵** or **↶** button (7) repeatedly until "DAY" or "NIGHT" appears in the display with the current setting.
- ⇨ Press the **↵** or **↶** button (7) to switch between the brightness levels.

When you have finished making your changes,

- ⇨ press the **MENU** button (9).

ADJUSTING THE DISPLAY SETTINGS

Adjusting the viewing angle

You can adjust the display's viewing angle to suit the installation position of the device in your vehicle.

- ⇒ Press the **MENU** button (9).
- ⇒ Press the **↵** or **↶** button (7) repeatedly until "DISPLAY MENU" appears in the display.
- ⇒ Press the **OK** button (10).
- ⇒ Press the **↵** or **↶** button (7) repeatedly until "ANGLE" appears in the display with the current setting.
- ⇒ Press the **↶** or **↷** button (7) to adjust the viewing angle.

When you have finished making your changes,

- ⇒ press the **MENU** button (9).

Setting the display illumination colour (only Acapulco MP54)

When setting the display illumination, you can choose one of four preset colours or you can mix a colour yourself from the RGB spectrum (red-green-blue) or you can select a colour during a colour scan.

Selecting a preset colour

Four different colours are already stored in the device. "Ocean" (blue), "Amber", "Sunset" (red-orange) and "Nature" (green) are available. Select a colour that best suits your vehicle interior.

- ⇒ Press the **↵** or **↶** button (7) repeatedly until "DISPLAY MENU" appears in the display.

- ⇒ Press the **OK** button (10).
- ⇒ Press the **↵** or **↶** button (7) repeatedly until "DISPLAY COLOR" appears in the display.
- ⇒ Press the **OK** button (10).
- ⇒ Press the **↵** or **↶** button (7) repeatedly until the colour that you want is displayed.

When you have finished making your changes,

- ⇒ press the **OK** (10) button and then the **MENU** button (9).

The settings are saved.

Mixing a colour for the display illumination

To customise the display illumination to suit your tastes you can mix a colour yourself using the three primary colours red, blue and green.

- ⇒ Press the **↵** or **↶** button (7) repeatedly until "DISPLAY MENU" appears in the display.
- ⇒ Press the **OK** button (10).
- ⇒ Press the **↵** or **↶** button (7) repeatedly until "DISPLAY COLOR" appears in the display.
- ⇒ Press the **OK** button (10).
- ⇒ Press the **↵** or **↶** button (7) repeatedly until "USER COLOR" appears in the display.
- ⇒ Press the **OK** button (10).

The menu for mixing your own colour is displayed. The top line displays "R", "G" and "B" with the current values. The "R" setting flashes.

ADJUSTING THE DISPLAY SETTINGS

- ⇒ Press the **↵** or **↶** button (7) repeatedly until the setting that you want is displayed.
- ⇒ Press the **↵** or **↷** button (7) to move the selection marker to the position after the other colours.
- ⇒ Adjust the other colour components to suit your preferences.

When you have finished making your changes,

- ⇒ press the **OK** (10) button and then the **MENU** button (9).

The settings are saved.

Selecting a display illumination colour during a colour scan

- ⇒ Press the **↵** or **↶** button (7) repeatedly until "DISPLAY MENU" appears in the display.
- ⇒ Press the **OK** button (10).
- ⇒ Press the **↵** or **↶** button (7) repeatedly until "DISPLAY COLOR" appears in the display.
- ⇒ Press the **OK** button (10).
- ⇒ Press the **↵** or **↶** button (7) repeatedly until "COLOR SCAN" appears in the display.

The device starts changing the display illumination colour.

If you want to select one of the colours,

- ⇒ press the **OK** (10) button and then the **MENU** button (9).

The settings are saved.

Mixing the button illumination colour (only Acapulco MP54)

You can mix your own button/key illumination colour using the two primary colours red and green.

- ⇒ Press the **↵** or **↶** button (7) repeatedly until "DISPLAY MENU" appears in the display.
- ⇒ Press the **OK** button (10).
- ⇒ Press the **↵** or **↶** button (7) repeatedly until "KEY COLOR" appears in the display.
- ⇒ Press the **OK** button (10).

The menu for mixing your own colour is displayed. The top line displays "R" for red and "G" for green with the current values. The "R" setting (red) flashes.

- ⇒ Press the **↵** or **↶** button (7) repeatedly until the value that you want is displayed.
- ⇒ Press the **↷** button (7) to move the selection marker to the position after "G".
- ⇒ Adjust the green colour component to suit your preferences.

When you have finished making your changes,

- ⇒ press the **MENU** button (9).

The settings are saved.

EXTERNAL AUDIO SOURCES

External audio sources

In addition to the CD changer, you can also connect another external audio source equipped with a line output. If no CD changer is connected to the device, you can connect two external audio sources. Audio sources can, for example, be portable CD players, MiniDisc players or MP3 players.

The AUX input must be activated in the menu.

If you want to connect an external audio source, you will need an adapter cable.

You can obtain this cable (Blaupunkt no.: 7 607 897 093) from your authorised Blaupunkt dealer.

Switching the AUX input on/off

- ⇨ Press the **MENU** button (9).
- ⇨ Press the **↵** or **↶** button (7) repeatedly until “AUX MENU” appears in the display.
- ⇨ Press the **OK** button (10).
- ⇨ Repeatedly press the **↵** or **↶** button (7) until “AUX2” or “AUX1” appears in the display.

If a CD changer is connected, “AUX1” is not available.

- ⇨ Use the **←→** buttons (7) to switch between the “ON” and “OFF” options.

When you have finished making your changes,

- ⇨ press the **MENU** button (9).

Note:

- If the AUX input is switched on, you can select it by pressing the **SRC** button (16).

TMC for dynamic navigation systems

TMC stands for "Traffic Message Channel". Traffic reports are broadcast digitally via TMC, which means they can be used by compatible navigation systems during route planning. Your car sound system has a TMC output, which you can use for connecting Blaupunkt navigation systems. You can find out from your Blaupunkt dealer which navigation systems can be used with your car sound system.

If a navigation system is connected and a TMC station is being received, TMC lights up in the display.

If dynamic navigation is active, the system will tune into a TMC station automatically.

Specifications

Amplifier

Output power: 4 x 18 watts sine at 14.4 V and 1% distortion factor at 4 ohms.
4 x 26 watts sine in accordance with DIN 45324 at 14.4 V at 4 ohms.
4 x 50 watts max. power

Tuner

Wavebands:

FM : 87.5 - 108 MHz
MW : 531 - 1 602 kHz
LW : 153 - 279 kHz

FM frequency response:

35 - 16,000 Hz

CD

Frequency response:

20 - 20,000 Hz

Pre-amp out

4 channels: 4 V

Input sensitivity

AUX input: 2 V / 6 k Ω

Tel./Navi input: 10 V / 1 k Ω

Subject to changes!

Service-Nummern / Service numbers / Numéros du service après-vente / Numeri del servizio di assistenza / Servicenummers / Telefonnummer för service / Números de servicio / Número de serviço / Servicenumre

Country:	Phone:	Fax:	WWW:
Germany	(D) 0180-5000225	05121-49 4002	http://www.blaupunkt.com
Austria	(A) 01-610 39 0	01-610 39 391	
Belgium	(B) 02-525 5444	02-525 5263	
Denmark	(DK) 44 898 360	44-898 644	
Finland	(FIN) 09-435 991	09-435 99236	
France	(F) 01-4010 7007	01-4010 7320	
Great Britain	(GB) 01-89583 8880	01-89583 8394	
Greece	(GR) 210 94 27 337	210 94 12 711	
Ireland	(IRL) 01-4149400	01-4598830	
Italy	(I) 02-369 62331	02-369 62464	
Luxembourg	(L) 40 4078	40 2085	
Netherlands	(NL) 023-565 6348	023-565 6331	
Norway	(N) 66-817 000	66-817 157	
Portugal	(P) 01-2185 00144	01-2185 11111	
Spain	(E) 902-120234	916-467952	
Sweden	(S) 08-7501500	08-7501810	
Switzerland	(CH) 01-8471644	01-8471650	
Czech. Rep.	(CZ) 02-6130 0441	02-6130 0514	
Hungary	(H) 01-333 9575	01-324 8756	
Poland	(PL) 0800-118922	022-8771260	
Turkey	(TR) 0212-3350677	0212-3460040	
USA	(USA) 800-2662528	708-6817188	
Brasil (Mercosur)	(BR) +55-19 3745 2769	+55-19 3745 2773	
Malaysia (Asia Pacific)	(MAL) +604-6382 474	+604-6413 640	

Blaupunkt GmbH

